



LOGIC
TECHNOLOGIES

PRODUCT SPECIFICATION

DESCRIPTION

TFT Module – 2.4”
240 x (RGB) x 320
Full viewing angle- MVA display

PART NUMBER
LTDD240320024-L5

VERSION
1.1

ROHS COMPLIANT

Table of Contents

- GENERAL INFORMATION
- MECHANICAL DIMENSIONS
- ABSOLUTE MAXIMUM RATINGS
- ELECTRICAL CHARACTERISTICS
- BACKLIGHT CHARACTERISTICS
- ELECTRO-OPTICAL CHARACTERISTICS
- INTERFACE DESCRIPTION
- INPUT SIGNAL DATA MAPPING
- TIMING CHART & DATA
- RELIABILITY TESTING
- INSPECTION CRITERIA
- INSPECTION STANDARD
- PRECAUTIONS FOR USING LCD MODULES

- GENERAL INFORMATION

Item	Contents	Unit
LCD Type	Transmissive / Normal white	---
Technology	MVA TFT	-
Viewing Direction	All	O'clock
Module dimensions (W x H x T)	42.72 x 60.40 x 1.93 (Note)	mm
Active area (W x H)	36.72 x 48.96	mm
Number of pixels	240 x 3 (RGB) x 320	---
Pixel pitch (W x H)	0.153 x 0.153	mm ²
Colours	262k	---
Contrast ratio	500	---
Backlight	LED (4 in series)	---
Controller IC	ILI9325C or equivalent	---
Interface	MCU 16-bit	---
Operating temperature	-20 to +70	°C
Storage temperature	-30 to +80	°C

Note: Except FPC and bumps.

- ABSOLUTE MAXIMUM RATINGS

Parameter	Symbol	Min.	Max.	Unit	Note
Power Voltage	V_{CI}	- 0.3	4.6	V	GND = 0
Input voltage	IOV_{CC}	- 0.5	$V_{CI}+0.3$	V	
LED Forward Voltage	V_F	---	3.4	V	If = 25mA
LED Forward Current	I_F	---	25	mA	Per LED
Operating Temperature	T_{OPR}	- 20	70	°C	
Storage temperature	T_{ST}	- 30	80	°C	

Note: Response time will be slower (delayed) at lower temperatures approaching the maximum operating temperature. At temperatures approaching the maximum operating temperature the LCD will experience a darker color. However this phenomena is an inherent property of LCDs and in no way means the LCD has malfunctioned.

- ELECTRICAL CHARACTERISTICS

Parameter	Symbol	Min	Typ.	Max	Unit	Remark
Supply Voltage	V_{CI}	2.5	2.8	3.3	V	
	IOV_{CC}	1.6	2.8	3.3	V	
Input Voltage High	V_{IH}	0.8 IOV_{CC}	---	IOV_{CC}	V	
Input Voltage Low	V_{IL}	-0.3	---	0.2 IOV_{CC}	V	
Power Consumption LCD Panel + Controller IC	W_{LCD+IC}	--	74	---	mW	Note 1

Note 1: V_{CI} = 2.8V, T_a =25°C, Frame Rate = 70Hz, all pixels black. Not include backlight.

- BACKLIGHT CHARACTERISTICS

Item	Symbol	Min.	Typ.	Max.	Unit	Condition
Forward Current Voltage	V_F	12.0	12.8	13.6	V	
Forward Current	I_F	---	20	25	mA	
Backlight Power Consumption	W_{BL}	---	254	340	mW	
LED Lifetime	---	20000	---	---	Hrs	Note 3

Notes

- **Backlight drive conditions : constant current driving method.**
- The LED driving condition is defined for the total backlight consumption.
- Forward Voltage adjusting should depend on Forward Current setting.
- Optical performance should be evaluated at T_a =25°C Only.

- If the LEDs are driven by high current, high ambient temperature & humidity condition the lifetime of the LEDs will be reduced.
- Operating life means brightness reduces to 50% of initial brightness.
- Typical operating lifetime is estimated data.

- BACKLIGHT SCHEMATIC

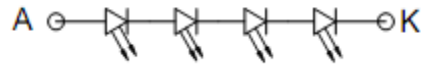

- ELECTRO-OPTICAL CHARACTERISTICS (backlight on)

Item	Symbol	Condition	Min.	Typ.	Max.	Unit	Refer	Note	
Response Time	T _{ON}	25°C	---	15	20	ms	Fig 1	1	
	T _{OFF}		---	20	30				
Contrast ratio (transmissive mode)	Cr	$\theta=0^\circ$	400	500	---	---	Fig 2	1	
NTSC	---	---	---	60	---	%			
Surface Luminance	Lv		280	350	---	cd/m ²	Fig 2	2	
Viewing angle ratio		$\varnothing=90^\circ$	60	70	---	deg	Fig 3	6	
		$\varnothing=270^\circ$	60	70	---				
		$\varnothing=0^\circ$	60	70	---				
		$\varnothing=180^\circ$	60	70	---				
CIE (x,y) chromaticity	Red	x	Backlight On	0.603	0.653	0.703	---	Fig 2.	5
		y		0.282	0.332	0.382			
	Green	x		0.264	0.314	0.364			
		y		0.525	0.575	0.625			
	Blue	x		0.087	0.137	0.187			
		y		0.083	0.133	0.183			
	White	x		0.257	0.307	0.357			
		y		0.291	0.341	0.391			

Note1. Contrast ratio (CR) is defined mathematically in Figure 2.

$$\text{Contrast Ratio} = \frac{\text{Average Surface Luminance with all white pixels (P1, P2, P3, P4, P5)}}{\text{Average Surface Luminance with all black pixels (P1, P2, P3, P4, P5)}}$$

Note 2. Surface luminance is the LCD surface from the surface with all pixels displaying white.
For more information see figure 2.

$$L_v = \text{Average Surface Luminance with all white pixels (P1, P2, P3, P4, P5...)}$$

Note 3. Uniformity of surface luminance, White, is defined mathematically in figure 2.

$$\text{White} = \frac{\text{Minimum Surface Luminance with all white pixels (P1, P2, P3, P4, P5)}}{\text{Maximum Surface Luminance with all white pixels (P1, P2, P3, P4, P5)}}$$

Note 4. Response time is the time required for the display to transition from white to black (rise time T_r) and from black to white (decay or fall time, T_f). The industry standard test equipment used is the Autronic-Melcher's Conoscope.

Note 5. CIE (x,y) chromaticity. The x,y value is determined by measuring luminance at each test position 1 through 5, then calculating the average value.

Note 6. The Viewing angle is the angle at which the contrast ratio is greater than 2. For a TFT module, the contrast ratio is greater than 10. The angles are determined for the horizontal or 'x' axis and the vertical or 'y' axis with respect to the 'z' axis, being the LCD surface reference. Also see figure 3.

Note 7. For viewing angle and response time testing, the testing data is based on Autronic-Melcher's BM-7A. For the contrast ratio, surface luminance, luminance uniformity and chromaticity (CIE), the test data is based on the industry's standard SR-3A photo detector.

Note 8. For TFT modules, grey scale reversing occurs in the direction of the panel viewing angle.

Figure 1. Definition of response time

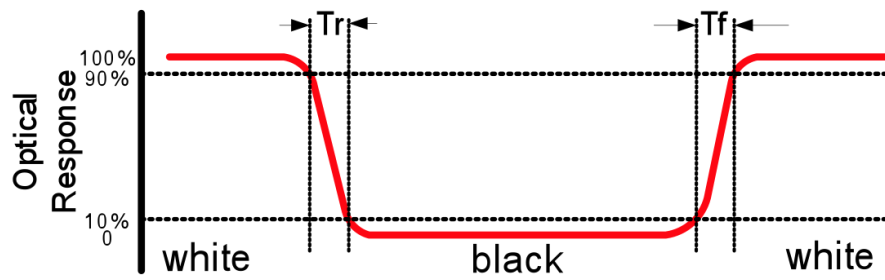

Figure 2. Measuring contrast ratio, surface luminance, luminance uniformity and CIE (chromaticity.)

A : 5mm, B : 5mm, H, V : Active area, Light spot size mm, 500mm distance from the LCD surface to the detector lens.
Measurement instrument is Topcon's luminance meter BM-5.

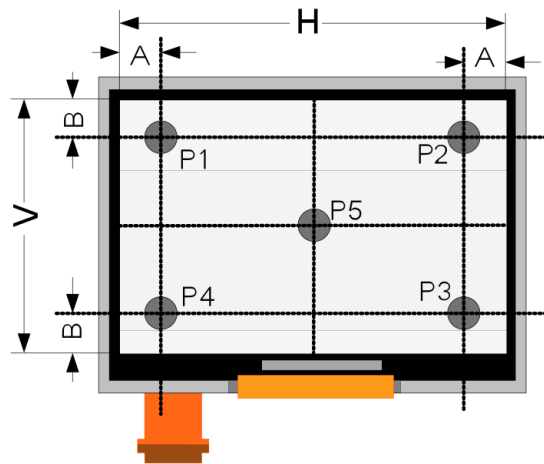
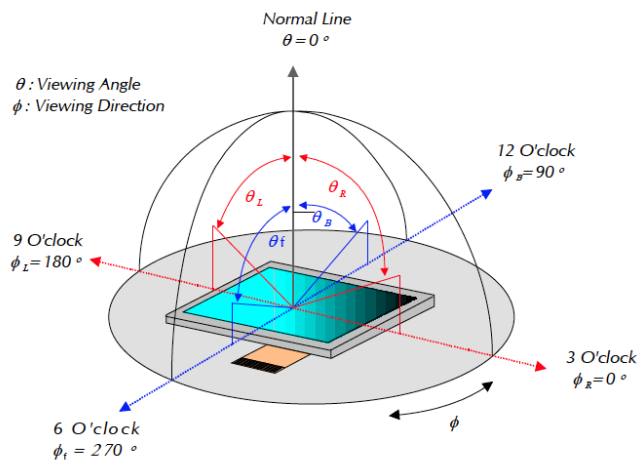

Figure 3. Definition of viewing angle



- INTERFACE DESCRIPTION

Pin	Symbol	I/O	Description	
1	GND	P	Ground	
2	IM0	P	IM3="GND", IM0="GND", then 16bit Interface IM3="GND", IM0="IOVCC", then 8bit Interface IM3="IOVCC", IM0="GND" then 18bit Interface IM3="IOVCC" IM0="IOVCC", then 9bit Interface	
3	IM3	P		
4	Frame	I		Frame head pulse signal
5	GND	P		Ground
6	DB17	I	16bit Interface RAM Write DB17~DB10,DB8~DB1 Instruction set DB17~DB10,DB8~DB1 DB9,DB0 fixed IOVCC or GND	
7	DB16	I		
8	DB15	I		
9	DB14	I		
10	DB13	I		
11	DB12	I		
12	DB11	I		8bit Interface RAM Write DB17~DB10 Instruction set DB17~DB10 DB9~DB0 fixed IOVCC or GND
13	DB10	I		
14	DB9	I		
15	DB8	I		18bit Interface RAM Write DB17~DB0 Instruction set DB17~DB10,DB8~DB1
16	IOVCC	I		
17	DB7	I		
18	DB6	I	9bit Interface RAM Write DB17~DB9 Instruction set DB17~DB10 DB8~DB0 fixed IOVCC or GND	
19	DB5	I		
20	DB4	I		
21	DB3	I		
22	DB2	I		IOVCC : Logic power supply (1.65V~3.3V)
23	DB1	I		
24	DB0	I		
25	/CS	I	Chip select signal	
26	RS	I	Display data/Command selection pin RS="H":Display data. RS="L":Command data.	
27	/WR	I	Write :Low active	
28	/RD	I	Read: Low active	
29	/RESET	I	RESET: Low active	
30	VCI	I	Analog power supply (2.5V~3.3V)	
31	GND	P	Ground	
32	LED+	P	LED power anode	
33	GND	P	Ground Ground	
34	LED-	P	LED power cathode	
35	GND	P	Ground	

Block Diagram

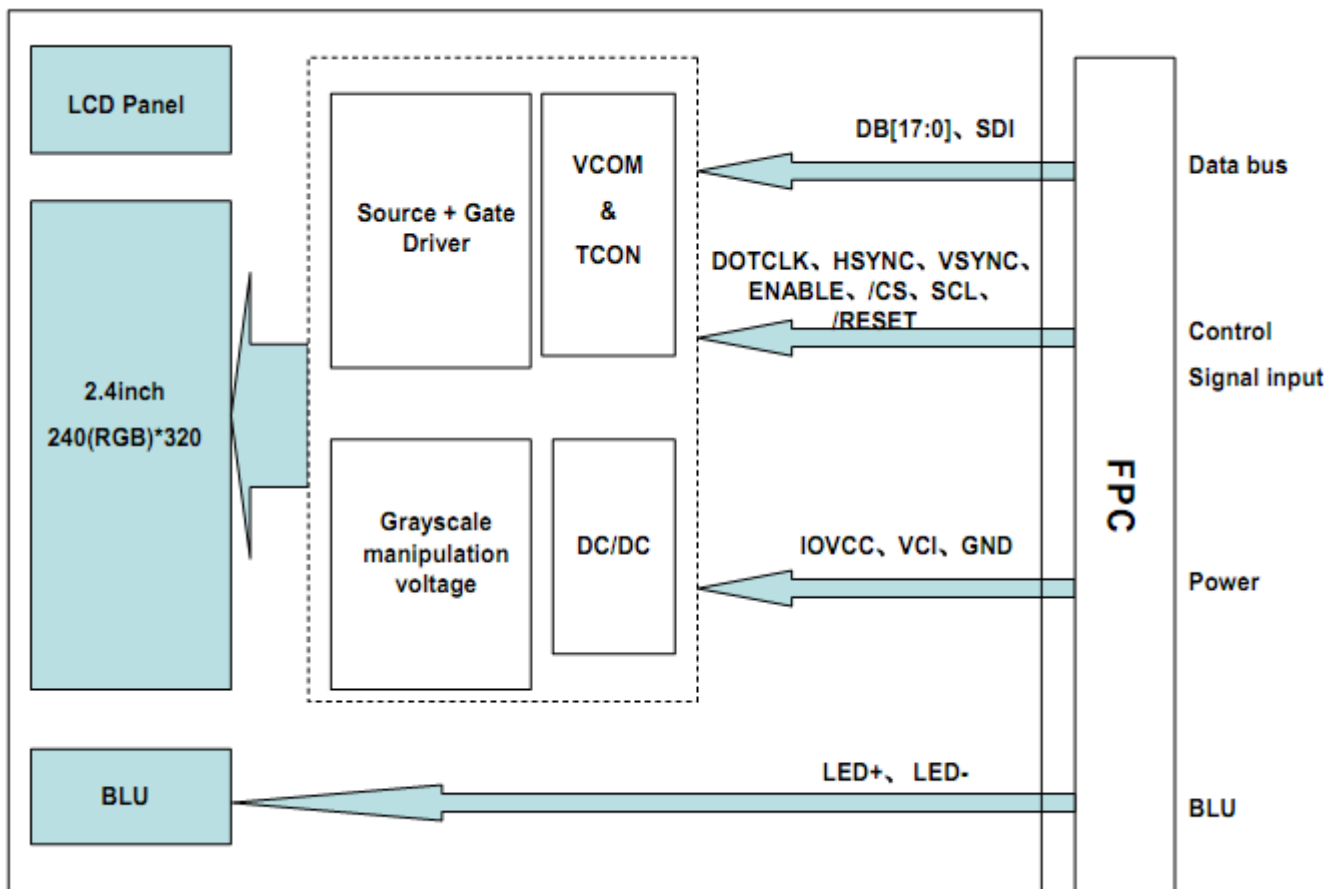

• TIMING CHART and DATA

○ 8080 MCU Interface timing

Normal Write Mode (IoVCC = 1.65~3.3V)

Item	Symbol	Unit	Min.	Typ.	Max.	Test Condition
Bus cycle time	Write	t_{CYCW}	ns	80	-	-
	Read	t_{CYCR}	ns	300	-	-
Write low-level pulse width	PW_{LW}	ns	50	-	500	-
Write high-level pulse width	PW_{HW}	ns	15	-	-	-
Read low-level pulse width	PW_{LR}	ns	150	-	-	-
Read high-level pulse width	PW_{HR}	ns	150	-	-	-
Write / Read rise / fall time	t_{WRr}/t_{WRF}	ns	-	-	25	-
Setup time	Write (RS to nCS, E/nWR)	t_{AS}	ns	10	-	-
	Read (RS to nCS, RW/nRD)			5	-	-
Address hold time	t_{AH}	ns	5	-	-	-
Write data set up time	t_{DSW}	ns	10	-	-	-
Write data hold time	t_H	ns	15	-	-	-
Read data delay time	t_{DDR}	ns	-	-	100	-
Read data hold time	t_{DHR}	ns	5	-	-	-

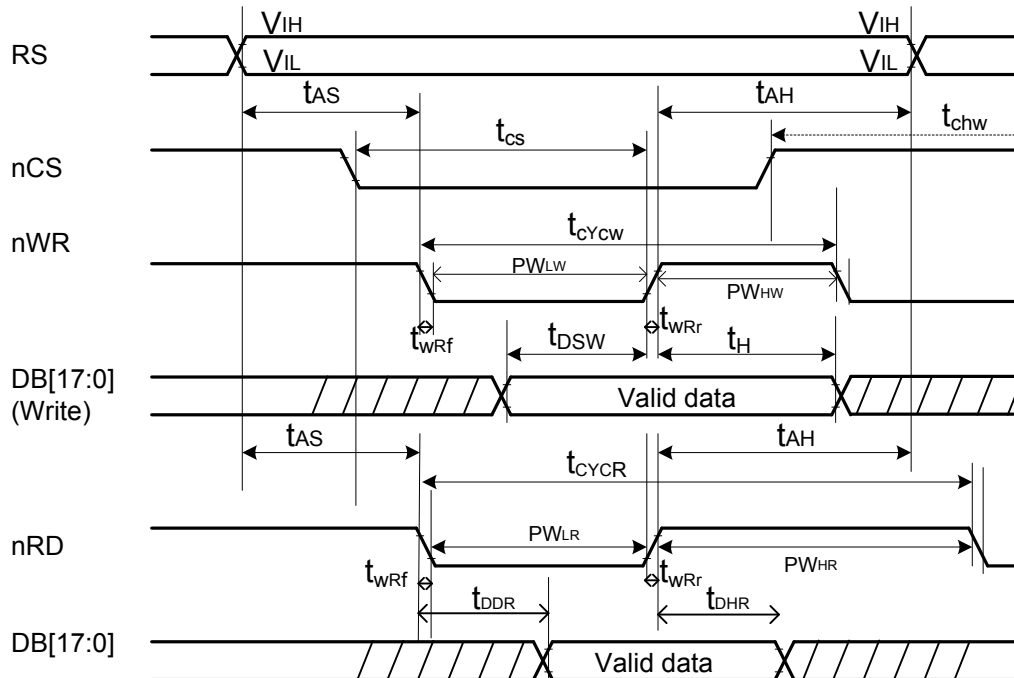

- RELIABILITY TESTING

NO.	Item	Condition	Criteria
1	High Temperature Operating	70°C +/-2°C, 240Hrs	IEC60068-2-1, GB2423.2
2	Low Temperature Operating	-20°C +/-2°C, 240Hrs	IEC60068-2-1 GB2423.1
3	High Temperature Storage	80°C +/-2°C, 240Hrs	IEC60068-2-1 GB2423.2
4	Low Temperature Storage	-30°C +/-2°C, 240Hrs	IEC60068-2-1 GB2423.2
5	Hi Temperature & High Humidity Operation	50°C, 90%RH max, 240Hrs	IEC60068-2-78 GB/T2423.3
6	Vibration (non operating)	Frequency range:10~55Hz, Stroke:1.5mm Sweep:10Hz~ 55Hz~10Hz2hours for each direction of x.y.z (6 hours for total)	IEC60068-2-6 GB/T2423.10
7	Package Vibration Test	Random Vibration: 0.015GxG/Hz for 5-200Hz, -6dB/Octave from 200-500Hz 2 hours for each direction of X,Y,Z (6 hours for total)	IEC60068-2-34 GB/T2423.11
8	Thermal Shock (non operating)	-20°C to 30min to 70°C, 30min Change time: 5min, 100 cycles	Start with cold temperature, End with high temperature, IEC60068-2- 14:1984,GB2423.22
9	Drop Test (packaged)	Height:80 cm, 1 corner, 3 edges, 6 surfaces	IEC60068-2-32 GB/T2423.8
10	Shock (non-operation)	80G 6ms, ±X,±Y,±Z 3 times for each direction	IEC60068-2-27 GB/T2423.5
11	ESD (operation)	C=150pF,R=330Ω, Air:±15Kv, Contact:±8Kv, 10times/terminal	IEC61000-4-2 GB/T17626.2

Notes:

1. Test samples are applied to one test item.
2. Sample size for each test item is 2-10pcs.
3. For humidity testing, a pure water resistance of >10MW should be used.
4. (a) In the case of a malfunction caused by ESD damage, if the LCM returns to it's normal state after resetting, the item is considered to have passed the ESD test.

- (b) It is recommended to use an anti-static blower (ioniser) to reduce the electro-static voltage in the working area.
 - (c) When removing the protection film from the LCM panel, peel off the film slowly (more than 1sec) while blowing the ioniser towards the peeling area to minimize ESD. This will reduce the risk of damaging the electrical circuitry.
5. EL backlights are exempt from the reliability testing with respect to temperature and humidity. Some defects may occur such as black spots or blemishes due to the inherent chemical reaction of humidity with fluorescent EL.
 6. If it is installed, please use the automatic test mode on the LCM &/or demonstration box when testing.

• INSPECTION CRITERIA

This specification is designed to be used as the standard acceptance/rejection criteria for normal LCM products.

1. Sampling plan.

The sampling plan according to GB/T 2828.1-2003 / ISO2859-16 1999 and ANSI/ASQC Z1.4 1993, normal level 2 and based on:

- Major defect: AQL 0.65
- Minor defect: AQL 1.5

2. Inspection condition

- The viewing distance for cosmetic inspection is approximately 30cm with the naked eye, and under an environment of 20-40W light intensity, in all directions, within 45° against a perpendicular line. (Normal temperature 20-25°C and normal humidity 60+/-15 RH.)
- Driving voltage - The Vop value from which the most optimal contrast can be obtained near the specified Vop in the specification (within +/-0.5V of the typical value at 25°C.)

3. Definition of inspection zone in LCD.

Zone A : active pixel area

Zone B : viewing area except Zone A (Zone A + Zone B = Minimum viewing area)

Zone C : Outside viewing area (invisible area after assembling customer's product.

Figure 4 inspection zones in an LCD

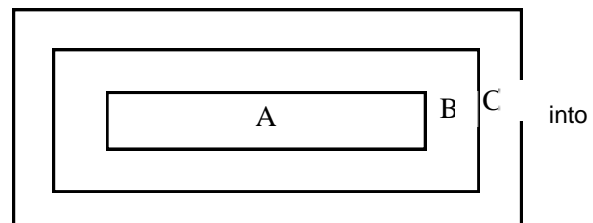

Note: As a general rule visual defects in Zone C are permissible when there is no visual effect once assembled into the customer's product.

• INSPECTION STANDARD

• MAJOR CRITERIA

Item No	Item to be inspected	Inspection standard	Classification
1	All functional defects	1) No display 2) Display abnormal 3) Missing vertical or horizontal segment 4) Short circuit 5) Backlight not working, flickering and abnormal light	Major
2	Missing	Missing component	
3	Outline dimension	Overall outline dimension beyond the drawing dimension is not allowed	

• COSMETIC CRITERIA

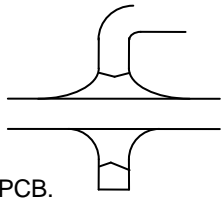
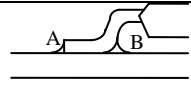
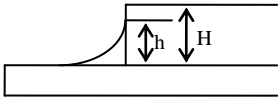
No.	Item	Judgment Criteria	Partition
1	Difference in Spec.	None allowed	Major
2	Pattern peeling	No substrate pattern peeling and floating	Major
3	Soldering defects	No soldering missing No soldering bridge No cold soldering	Major Major Minor
4	Resist flaw on substrate	Invisible copper foil (Ø0.5mm or more) on substrate pattern	Minor
5	Accretion of metallic Foreign matter	No soldering dust No accretion of metallic foreign matters (Not exceed Ø0.2mm)	Minor Minor
6	Stain	No stain to spoil cosmetic badly	Minor
7	Plate discoloring	No plate fading, rusting and discoloring	Minor
8	Solder amount	a. Soldering side of PCB Solder to form a 'Filet' all around the lead. Solder should not hide the lead form perfectly. (too much) b. Components side (In case of 'Through Hole PCB') 	Minor
	2. Flat packages	Either 'toe' (A) or 'heel' (B) of the lead to be covered by 'Filet'. Lead form to be assume over solder. 	Minor
	3. Chips	$(3/2) H \geq h \geq (1/2) H$ 	Minor
9	Solder ball/solder splash	a) The spacing between solder ball and the conductor or solder pad $h \geq 0.13\text{mm}$. The diameter of the solder ball $d \leq 0.15\text{mm}$. b) The quantity of solder balls or solder splashes isn't more than 5 in 600mm ² . c) Solder balls / splashes do not violate minimum electrical clearance d) Solder balls/splashes must be not be able to be dislodged with	Minor Minor Major Minor

normal product usage

• COSMETIC CRITERIA (non-operating)

No.	Defect	Judgment Criteria	Classification										
1	Spots	In accordance with Screen Cosmetic Criteria (Operating) No.1.	Minor										
2	Lines	In accordance with Screen Cosmetic Criteria (Operating) No.2.	Minor										
3	Bubbles in polarizer	<table border="1"> <thead> <tr> <th>Size : d mm</th> <th>Acceptable Qty in active area</th> </tr> </thead> <tbody> <tr> <td>d ≤ 0.3</td> <td>Disregard</td> </tr> <tr> <td>0.3 < d ≤ 1.0</td> <td>3</td> </tr> <tr> <td>1.0 < d ≤ 1.5</td> <td>1</td> </tr> <tr> <td>1.5 < d</td> <td>0</td> </tr> </tbody> </table>	Size : d mm	Acceptable Qty in active area	d ≤ 0.3	Disregard	0.3 < d ≤ 1.0	3	1.0 < d ≤ 1.5	1	1.5 < d	0	Minor
Size : d mm	Acceptable Qty in active area												
d ≤ 0.3	Disregard												
0.3 < d ≤ 1.0	3												
1.0 < d ≤ 1.5	1												
1.5 < d	0												
4	Scratch	In accordance with spots and lines operating cosmetic criteria. When the light reflects on the panel surface, the scratches are not to be remarkable.	Minor										
5	Allowable density	Above defects should be separated more than 30mm each other.	Minor										
6	Coloration	Not to be noticeable coloration in the viewing area of the LCD panels. Back-lit type should be judged with back-lit on state only.	Minor										
7	Contamination	Not to be noticeable.	Minor										

• COSMETIC CRITERIA (operating)

No.	Defect	Judgment Criteria	Classification																				
1	Spots	<p>A) Clear</p> <table border="1"> <thead> <tr> <th>Size : d mm</th> <th>Acceptable Qty in active area</th> </tr> </thead> <tbody> <tr> <td>d ≤ 0.1</td> <td>Disregard</td> </tr> <tr> <td>0.1 < d ≤ 0.2</td> <td>6</td> </tr> <tr> <td>0.2 < d ≤ 0.3</td> <td>2</td> </tr> <tr> <td>0.3 < d</td> <td>0</td> </tr> </tbody> </table> <p>Note : Including pin holes and defective dots which must be within one pixel size.</p> <p>B) Unclear</p> <table border="1"> <thead> <tr> <th>Size : d mm</th> <th>Acceptable Qty in active area</th> </tr> </thead> <tbody> <tr> <td>d ≤ 0.2</td> <td>Disregard</td> </tr> <tr> <td>0.2 < d ≤ 0.5</td> <td>6</td> </tr> <tr> <td>0.5 < d ≤ 0.7</td> <td>2</td> </tr> <tr> <td>0.7 < d</td> <td>0</td> </tr> </tbody> </table>	Size : d mm	Acceptable Qty in active area	d ≤ 0.1	Disregard	0.1 < d ≤ 0.2	6	0.2 < d ≤ 0.3	2	0.3 < d	0	Size : d mm	Acceptable Qty in active area	d ≤ 0.2	Disregard	0.2 < d ≤ 0.5	6	0.5 < d ≤ 0.7	2	0.7 < d	0	Minor
Size : d mm	Acceptable Qty in active area																						
d ≤ 0.1	Disregard																						
0.1 < d ≤ 0.2	6																						
0.2 < d ≤ 0.3	2																						
0.3 < d	0																						
Size : d mm	Acceptable Qty in active area																						
d ≤ 0.2	Disregard																						
0.2 < d ≤ 0.5	6																						
0.5 < d ≤ 0.7	2																						
0.7 < d	0																						

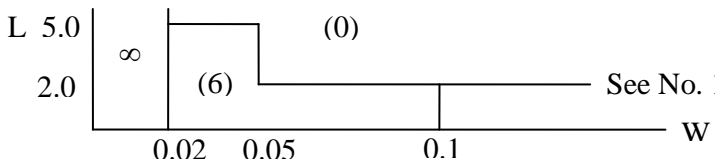
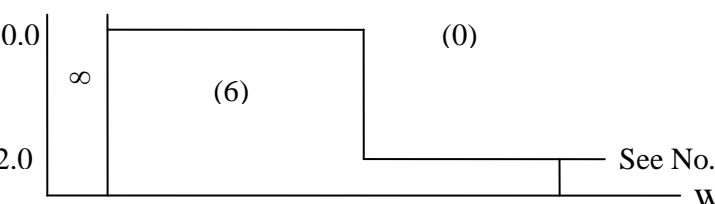
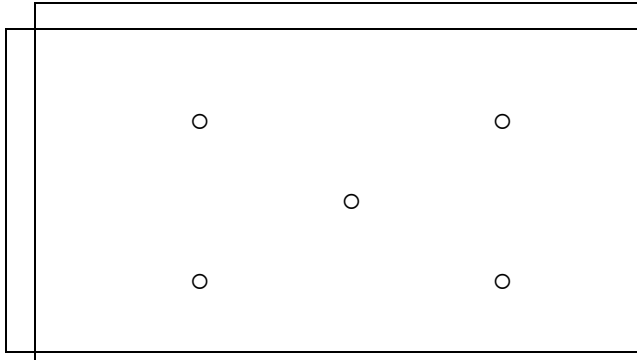
2	Lines	<p>A) Clear</p>  <p>Note : () - Acceptable Qty in active area L - Length (mm) W - Width (mm) ∞ - Disregard</p> <p>B) Unclear</p> 	Minor
3	Rubbing line	Not to be noticeable.	
4	Allowable density	Above defects should be separated more than 10mm each other.	Minor
5	Rainbow	Not to be noticeable.	Minor
6	Dot size	To be 95% ~ 105% of the dot size (Typ.) in drawing. Partial defects of each dot (ex. pin-hole) should be treated as 'spot'. (see Screen Cosmetic Criteria (Operating) No.1)	Minor
7	Uneven brightness (only back-lit type module)	<p>Uneven brightness must be $B_{MAX} / B_{MIN} \leq 2$</p> <ul style="list-style-type: none"> - BMAX : Max. value by measure in 5 points - BMIN : Min. value by measure in 5 points <p>Divide active area into 4 vertically and horizontally. Measure 5 points shown in the following figure.</p>  <p>○ : Measuring points</p>	Minor

Note :

- (1) Size : $d = (\text{long length} + \text{short length}) / 2$
- (2) The limit samples for each item have priority.
- (3) Complex defects are defined item by item, but if the number of defects are defined in above table, the total number should not exceed 10.
- (4) In case of 'concentration', even the spots or the lines of 'disregarded' size should not allowed.

Following three situations should be treated as 'concentration'.

- 7 or over defects in circle of $\varnothing 5\text{mm}$.
- 10 or over defects in circle of $\varnothing 10\text{mm}$.
- 20 or over defects in circle of $\varnothing 20\text{mm}$.

- PRECAUTIONS FOR USING LCD MODULES

- Handling Precautions

- (1) The display panel is made of glass. Do not subject it to a mechanical shock by dropping it or impact.

- (2) If the display panel is damaged and the liquid crystal substance leaks out, be sure not to get any in your mouth. If the substance contacts your skin or clothes, wash it off using soap and water.

- (3) Do not apply excessive force to the display surface or the adjoining areas since this may cause the color tone to vary.

- (4) The polarizer covering the display surface of the LCD module is soft and easily scratched. Handle this polarizer carefully.

- (5) If the display surface becomes contaminated, breathe on the surface and gently wipe it with a soft dry cloth. If it is heavily contaminated, moisten cloth with one of the following solvents :

- Isopropyl alcohol

- Ethyl alcohol

- (6) Solvents other than those above-mentioned may damage the polarizer. Especially, do not use the following.

- Water

- Ketone

- Aromatic solvents

- (7) Exercise care to minimize corrosion of the electrode. Water droplets, moisture condensation or a current flow in a high-humidity environment, accelerate corrosion of the electrodes.

- (8) Install the LCD Module by using the mounting holes. When mounting the LCD module make sure it is free of twisting, warping and distortion. In particular, do not forcibly pull or bend the I/O cable or the backlight cable.

- (9) Do not attempt to disassemble or process the LCD module.

- (10) NC terminal should be open. Do not connect anything.

- (11) If the logic circuit power is off, do not apply the input signals.

- (12) To prevent destruction of the elements by static electricity, be careful to maintain an optimum work environment.

- Be sure to ground the body when handling the LCD modules.

- Tools required for assembling, such as soldering irons, must be properly grounded.

- To reduce the amount of static electricity generated, do not conduct assembling and other work under dry conditions.

- The LCD module is coated with a film to protect the display surface. Exercise care when peeling off this protective film since static electricity may be generated.

- Storage Precautions

When storing the LCD modules, avoid exposure to direct sunlight or to the light of fluorescent lamps. Keep the modules in bags (avoid high temperature / high humidity and low temperatures below the stated storage temperature of the LCM specification).

- Others

Liquid crystals solidify under low temperature (below the storage temperature range) leading to defective orientation or the generation of air bubbles (black or white). Air bubbles may also be generated if the module is subject to a low temperature.

If the LCD modules have been operating for a long time showing the same display patterns, the display patterns may remain on the screen as ghost images and a slight contrast irregularity may also appear. A normal operating status can be regained by suspending use for some time. It should be noted that this phenomenon does not adversely affect performance reliability.

To minimize the performance degradation of the LCD modules resulting from destruction caused by static electricity etc., exercise care to avoid holding the following sections when handling the modules.

- Exposed area of the printed circuit board.
- Terminal electrode sections.

• USING LCD MODULES

• Liquid Crystal Display Modules

LCD is composed of glass and polarizer. Pay attention to the following items when handling.

(1) Please keep the temperature within specified range for use and storage. Polarization degradation, bubble generation or polarizer peel-off may occur with high temperature and high humidity.

(2) Do not touch, push or rub the exposed polarisers with anything harder than an HB pencil lead (glass, tweezers, etc.).

(3) N-hexane is recommended for cleaning the adhesives used to attach front/rear polarisers and reflectors made of organic substances that may be damaged by chemicals such as acetone, toluene, ethanol and isopropyl alcohol.

(4) When the display surface becomes dusty, wipe gently with absorbent cotton or other soft material like chamois soaked in petroleum benzene. Do not scrub hard to avoid damaging the display surface.

(5) Wipe off saliva or water drops immediately, contact with water over a long period of time may cause deformation or color fading.

(6) Avoid contacting oil and fats.

(7) Condensation on the surface and contact with terminals due to cold will damage, stain or dirty the polarisers. After products are tested at low temperature they must be warmed up in a container before coming in contact with room temperature air.

(8) Do not put or attach anything on the display area to avoid leaving marks on.

(9) Do not touch the display with bare hands. This will stain the display area and degrade the insulation between the terminals.

(10) As glass is fragile. It tends to become chipped during handling especially on the edges.

(11) Mounting Method

The panel of the LCD Module consists of two thin glass plates with polarizers, which easily get damaged. Since the Module is fixed by utilizing fitting holes in the printed circuit board.

Extreme care should be taken when handling the LCD Modules.

(12) Caution against static charge

The LCD Module use C-MOS LSI drivers, so we recommend that you connect any unused input terminal to VDD or VSS, do not input any signals before power is turned on. And ground your body, Work/assembly table. And assembly equipment to protect against static electricity.

• Precaution for Soldering the LCM

	Manual Soldering	Machine Drag Soldering	Machine Pre-soldering
Non ROHS Product	290°C ~ 350°C Speed : 3 ~ 5 mm/s	330°C ~ 350°C Speed : 4 ~ 8mm/s	300°C ~ 330°C Time : 3 ~ 6S Pressure : 0.8 to 1.2Mpa
RoHS Product	340°C ~ 370°C Time : 3 ~ 5S.	350°C ~ 370°C Time : 4 ~ 8 mm/S.	330°C ~ 360°C Time : 3 ~ 6S. Pressure : 0.8 ~ 1.2Mpa.

(1) If solder flux is used, be sure to remove any remaining flux after finishing the soldering process. (This does not apply in the case of a non-halogen type of flux.) It is recommended that you protect the LCD surface with a cover during the soldering process to prevent any damage due to the flux sparks.

(2) When soldering a backlight panel and PCB, the panel and PCB should not be detached more than 3 times. The temperature determines this number and time conditions as mentioned in the above table, although there may be some variance depending on the actual temperature of the

soldering iron.

- (3) When removing a backlight panel from the PCB, ensure the solder has completely melted, otherwise the solder pads on the backlight panel and/or PCB may be damaged.

- Caution for operation

(1) It is recommended to drive LCDs within their specified voltage limit since the higher voltage than the upper limit shortens the LCD life. An electrochemical reaction due to direct current causes the LCD to deteriorate. Therefore, avoid the use of direct current drive.

(2) Response time will be extremely delayed at lower temperatures than the operating temperature range. At higher temperatures LCD's will experience a dark color. However those phenomena do not mean a malfunction or the LCD's. Once the LCDs are returned to the specified operating temperature range, the response time and colouration should return to the normal state.

(3) If the display area is physically pressed hard during it's operation, some pixels may be abnormally displayed, but should return to their normal condition after resetting the LCM.

(4) Moisture sitting on the LCM terminals is a cause for an electro-chemical reaction resulting in a terminal open circuit. Usage under the relative condition of 40°C, 50%RH or less is therefore required.

- Safety

- (1) It is recommended to crush any damaged or unnecessary LCDs into pieces and wash off the liquid crystal by using solvents such as acetone and ethanol, which should then be burned up later.
- (2) When any liquid crystal has leaked out of a damaged glass cell and comes in contact with skin, please wash it off well with soap and water.

- Warranty

Unless otherwise agreed between Logic Technologies Ltd and the customer, Logic Technologies will replace or repair any of its products that are found to be functionally defective when inspected in accordance with Logic Technologies' acceptance criteria (copies available upon request) for a period of one year from date of shipment. Cosmetic/visual defects must be returned to Logic Technologies within 90 days of shipment. Confirmation of such date shall be based on freight documents. The warranty liability of Logic Technologies is limited to the repair and/or replacement on the terms set forth above. Logic Technologies will not be responsible for any subsequent or consequential losses and/or events.

Returning products under warranty

No warranty can be granted if the precautions stated above have been disregarded. The typical examples of violations are:

- Broken LCD glass.
- PCB eyelet's damaged or modified.
- PCB conductors damaged.
- Circuit modified in any way, including addition of components.
- PCB tampered with by grinding, engraving or painting varnish.
- Soldering to or modifying the bezel in any manner.

Product repairs will be invoiced to the customer upon mutual agreement. Products must be returned with sufficient description of the failures and/or defects. Any connectors or cable installed by the customer must be removed completely without damaging the PCB eyelet's, conductors and terminals.